

02-06P

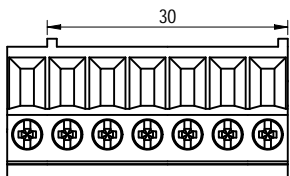

07P

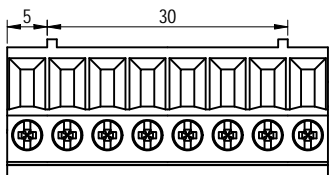

08P

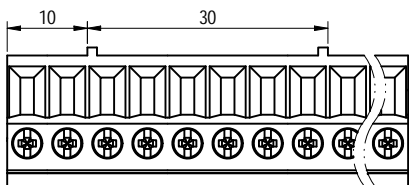

09-10P

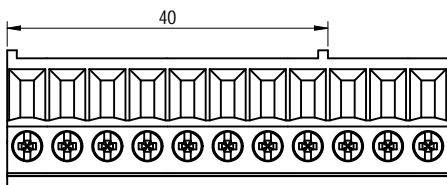

11P

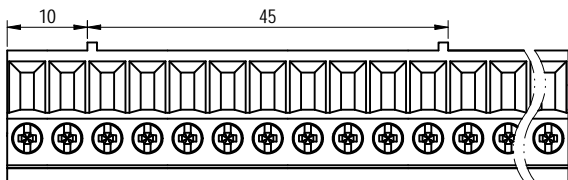

12-14P

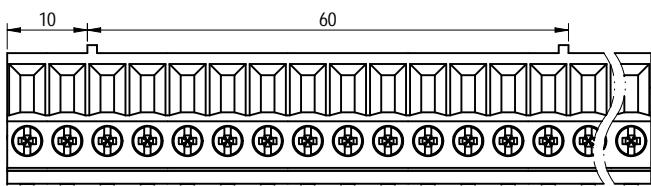

15-16P

公差/General tolerances (mm)													D	
0	>3	>6	>10	>18	>30	>50	>80	>120	>180	>250	>315	>400	>500	0.1/10
~3	~6	~10	~18	~30	~50	~80	~120	~180	~250	~315	~400	~500	~500	±2
±0.12	±0.18	±0.22	±0.26	±0.31	±0.37	±0.57	±0.80	±0.93	±1.05	±1.15	±1.60	±2.20	±2.50	

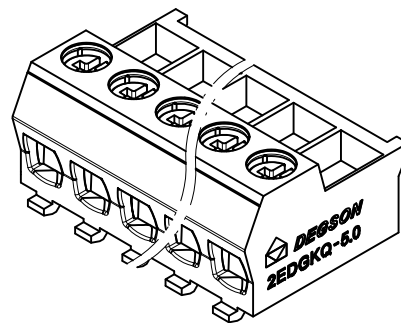
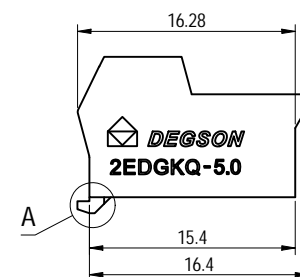
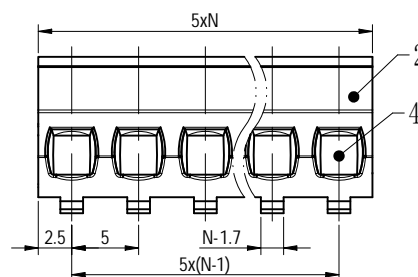
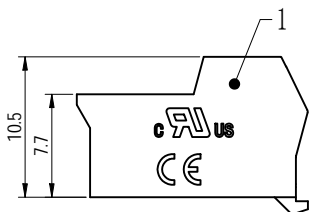
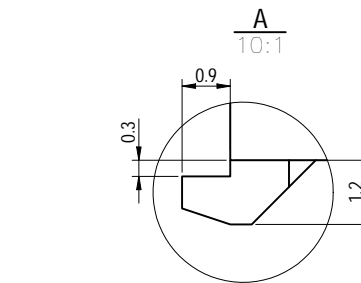
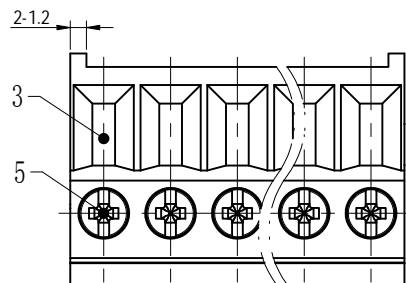

Note: The A&Z (H) in the name means: A(H) and Z(H).

ITEM	NAME OF PART	MATERIAL	NOTES
5	Screw	Steel	M3/Zn Plated
4	Cage	Copper alloy	M3/Ni Plated
3	Clamp	Copper alloy	Sn Plated
2	Cover	PA66	UL94V-0
1	Housing	PA66	UL94V-0

UL 标准/UL Standard:	B	C	D
额定电压/电压/Rated Voltage(V)/Current(A)	300/10	/	/

IEC 标准/IEC Standard:	III/3	III/2	II/2
过压类别/Overvoltage Category/污染等级/Pollution Degree	III/3	III/2	II/2
额定电压/电压/Rated Voltage(V)/Current(A)	/	250/10	/
额定脉冲电压(KV)/Rate Impulse Voltage(KV)	/	2.5	/
螺丝扭矩/Torque Tightening(N·m/Lb.in)	M3, 0.5/4.43		
线径范围(硬线和软线)/Wire Range(rigid and flexible)(AWG/mm ²)	28~14 / 0.2~1.5		
间距/Pitch(mm)/线数范围/Poles	5.0/N=02~16P		
剥线长度/Stripping length(mm)	6~7		
使用温度范围/Operating temperature(°C)	-40~+105		
符合RoHS环保要求/Conform to RoHS	Yes		

DEGSON		MATERIAL:	SURFACE/COLOR:		
APPD: 兰春华	2022.12.02	MAT NO./REV: - / 00	MAT STATUS: 批量		
CHKD: 姜耀志	2022.12.02	NAME: 2EDGKQ-5.0-XXP-1Y-00A&Z(H)			
DRFT: 朱岳鹏	2022.12.02	DRAWING NO. 200020120	TYPE: CUSTOMER DRAWING	DRAWING STATUS: 已发布	SCALE: 2.5:1
REV: 00	ECN:	DESCRIPTION:	DATE: 2022.12.02	SHEET: 1/1	

REV	ECN	DESCRIPTION	DRFT	DATE
00			朱岳鹏	2022.12.02

Transfer or duplication of this document as well as the utilization of its contents without the written permission of DEGSON is prohibited. All rights reserved for patent.